

Łącznik budowlany W-3

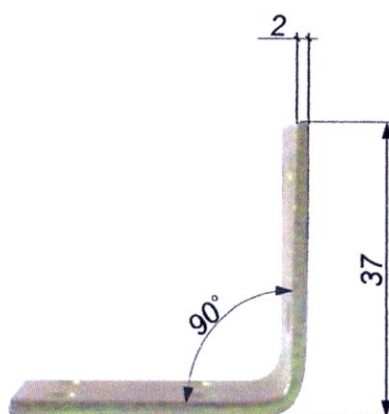
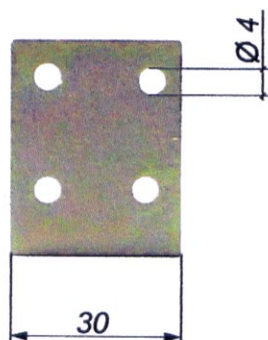

Wykończenie:

* Cynkowanie (żółta pasywacja)